

Alignment of Model 520

Tools Needed:

- 3/16" Allen wrench
- 5/32" Allen wrench, long handle (provided)
- 5/32" Allen wrench, short handle (provided)
- 5/16" Allen wrench (provided)
- 9/16" wrench
- Arbor wrench (provided)
- 1/2" wrench
- Adjustable wrench (optional)
- 1/2" socket and ratchet wrench with short extension
- 3/8" to 1/2" drill bit
- Small Straightblade screwdriver
- Medium Straightblade screwdriver
- Medium Phillips screwdriver
- High quality combination square

SAFETY

WARNING

Make sure the speed dial is set to "Slow", then turn off and unplug the Mark V before performing any ALIGNMENT procedure.

1. Complete **ALL** of the following procedures—and then recheck them at regular intervals. You **MUST** use an accurate combination square for alignment and adjustment. To check that your square is accurate, select a board with at least one straight and true edge. Place the square against the good edge and draw a line across the width. Flop the square over and hold it against the same edge and draw another line next to the first one. If the lines are parallel, your square is accurate.
2. All the parts and accessories which support or guide the stock **MUST** be aligned **parallel with or perpendicular to** the main spindle's plane of rotation. During the following alignment procedures the saw blade (provided in the accessories box) will represent the main spindle's plane of rotation.

NOTE

If you have installed casters (optional) on your Mark V, make sure they are retracted and the legs on the Mark V sit firmly on a level floor. Do this now.

Also, remember that your Mark V could possibly go out of alignment if it is moved to an area with varying floor levelness. Remember to recheck alignment and make needed adjustments after moving your Mark V, if needed.

ADJUST THE HEADREST LOCK

1. To check the headrest lock (15), grasp the way tubes near the tie bar (25) and pull up, as demonstrated by the right hand in Figure B-44.
2. If there is "give" in the lock, unlock the handle and use a medium Phillips screwdriver to turn the lock shaft (6) **clockwise**, as done by the left hand in Figure B-44. If the lock is difficult to operate, the shaft is too tight. To loosen, unlock the handle and turn the shaft **counterclockwise**.

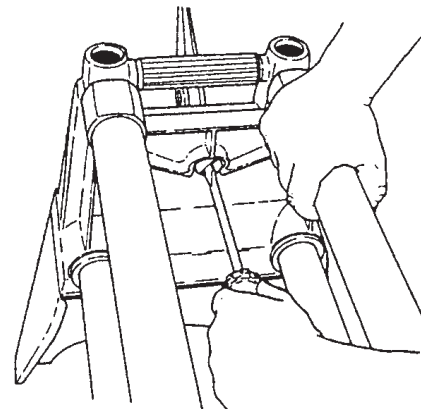

Figure B-44

ADJUST THE CARRIAGE LOCK

3. If the carriage lock handle (187) does not lock into the horizontal position or the carriage moves out of position, the lock needs adjusting. To adjust the lock, use a 1/2" socket with an extension and ratchet handle to tighten or loosen the nut located at the back of the carriage assembly, as shown in Figure B-45.

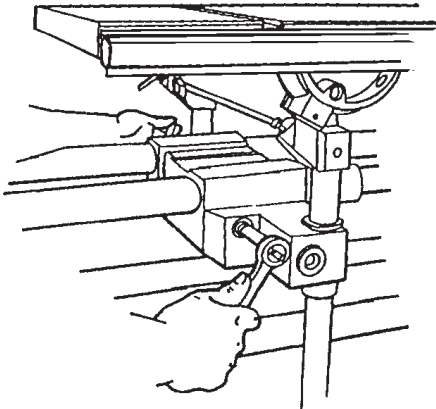

Figure B-45

4. When the carriage lock handle locks into the horizontal position and the carriage no longer moves when the handle is in the horizontal position, tighten the nut a final 1/4 turn.

WARNING

The carriage lock handle **MUST** lock into the horizontal position, otherwise the carriage lock may vibrate loose.

SET THE WORKTABLE'S 90° LEFT STOP**WARNING**

Always make sure the Mark V headstock and carriage are locked and all casters are raised off the floor before lifting the Mark V into the vertical drill press position.

5. Unlock the carriage and headstock. Move the headstock to the middle of the way tubes. Then move the carriage between the headstock and base mount (right side).
6. Tighten the headstock and carriage locks. Place the Mark V in the vertical position by loosening the headrest handle (15), firmly grasping the way tubes (20) near the headrest end, and lifting the tubes into the 90° position, as demonstrated in Figure B-46.

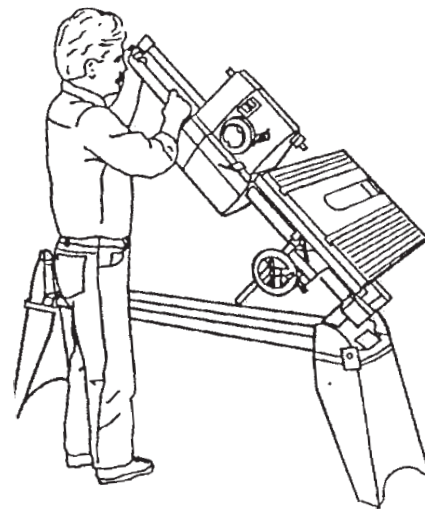

Figure B-46

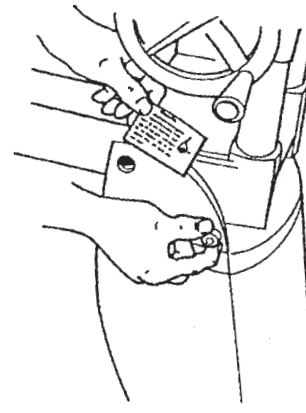

Figure B-47

7. See Figure B-47. Use your fingers to screw in the base lock (2). Note the base lock is slightly off center to the countersink found in the bench base, as shown in Figure B-48. This offset allows the base lock to more firmly hold the base in place.

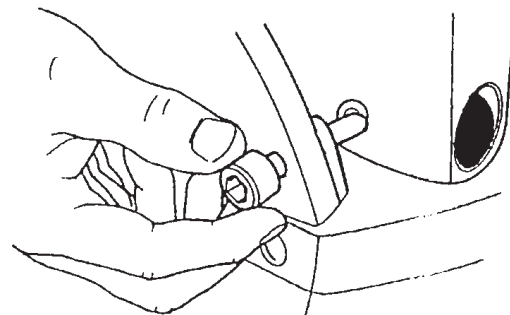

Figure B-48

8. Move the worktable into the 90° position by loosening the table tilt lock (165), as seen in Figure B-49, then putting the worktable in the horizontal 90° position, as shown in Figure B-50. Retighten the table tilt lock only enough to allow movement with firm pressure.
9. Use a 5/32" Allen wrench to remove the table insert, as demonstrated in Figure B-51.

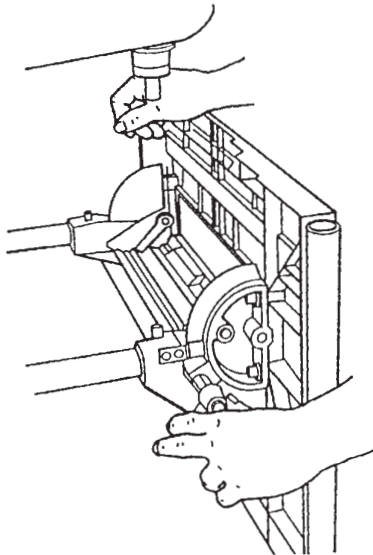

Figure B-49

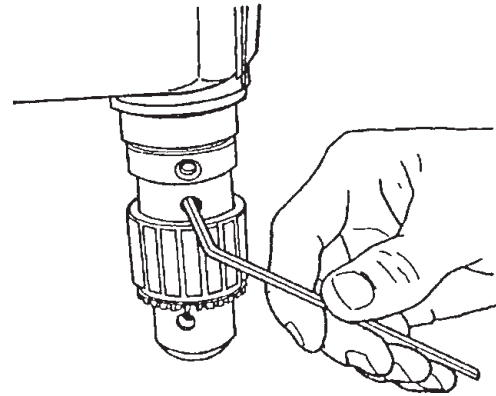

Figure B-52

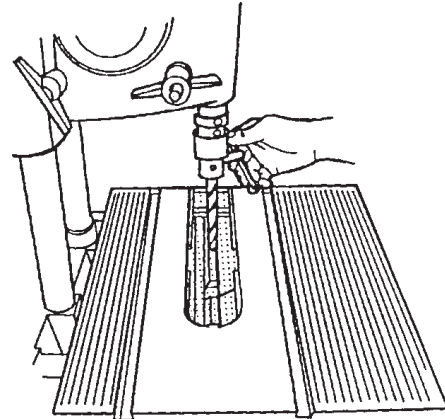

Figure B-53

11. Install a 3/8" to 1/2" straight drill bit in the drill chuck and use the chuck key to lock it place. See Figure B-53.

NOTE

Check the straightness of the drill bit by rolling it on a flat surface. You can also hand-rotate the drill chuck while holding the combination square against the drill bit and the table. If the bit is not straight DO NOT use it for these alignment instructions.

12. With the drill bit above the table opening, use the quill feed to extend the bit 1/2" into the table opening, as in Figure B-54.

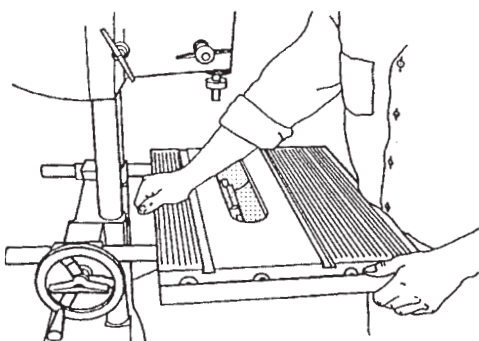

Figure B-50

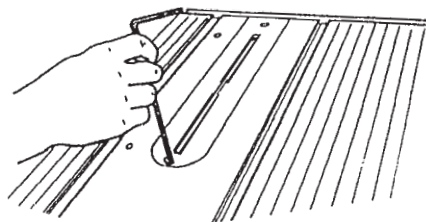

Figure B-51

10. To install the drill chuck, mount the chuck on the spindle and align the chuck's set screw with the spindle knob's set screw, as shown in Figure B-52. This allows the chuck's set screw to set on the flat part of the spindle. Use a 5/32" Allen wrench to securely tighten the drill chuck's set screw.

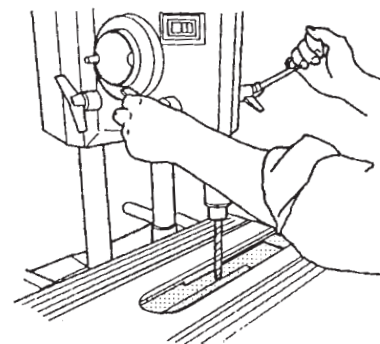

Figure B-54

13. Set the combination square against the bit and table, as shown in Figure B-55. The square should contact the bit along its entire length. When the table is exactly perpendicular to the drill bit, lock the table, as seen in Figure B-56.

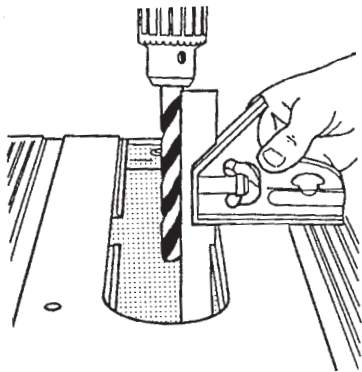

Figure B-55

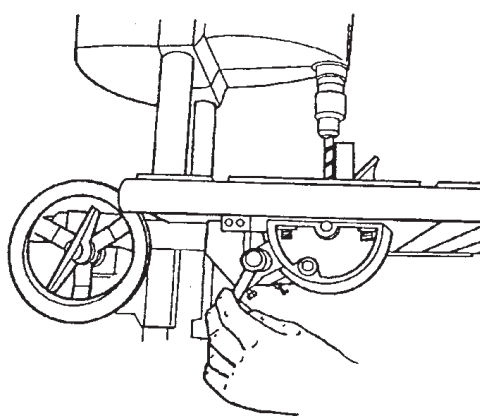

Figure B-56

14. Both 90° stops (shown in Figs. B-57 and B-58) should contact the underside of the table. If they don't, use a 1/2" wrench to adjust the stops.

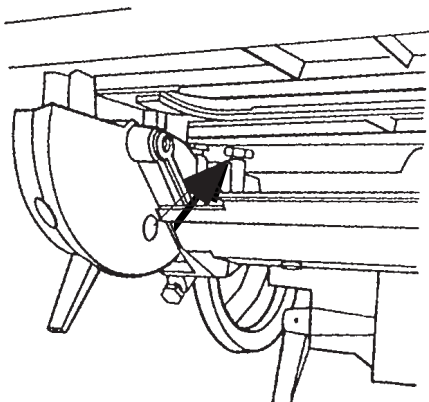

Figure B-57

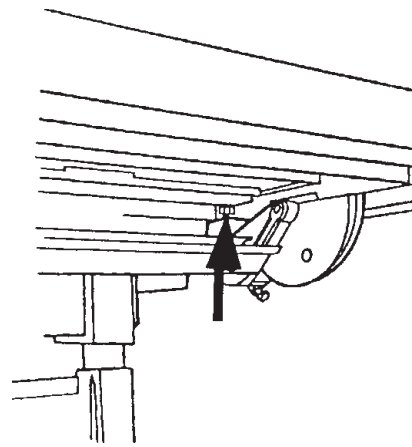

Figure B-58

15. Recheck the setting by loosening the tilt lock, moving the table, and then repeating Steps 13 and 14. (Rechecking the settings is very important!)

SET THE WORKTABLE'S 0° STOP

16. Remove the drill bit and drill chuck from the spindle.

17. Loosen the base lock (2). Firmly grasp the way tubes and lower the headstock into the horizontal position, then engage the head rest.

18. Loosen the table tilt lock and place the table in the horizontal "0" position. Retighten the table tilt lock only enough to allow movement with firm pressure.

19. Mount the saw blade on the arbor:

- a. Remove the arbor nut by turning it clockwise, as seen in Figure B-59a. Hold the arbor with the threaded part pointing to the left.

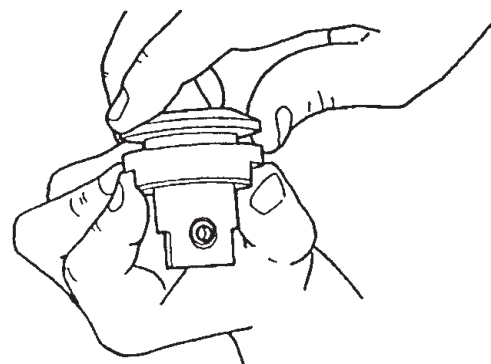

Figure B-59a

- b. Hold the blade with the teeth pointing toward you, as shown in Figure B-59b, then insert the arbor through the hole. Replace the nut and finger tighten it, as in Figure B-59c.

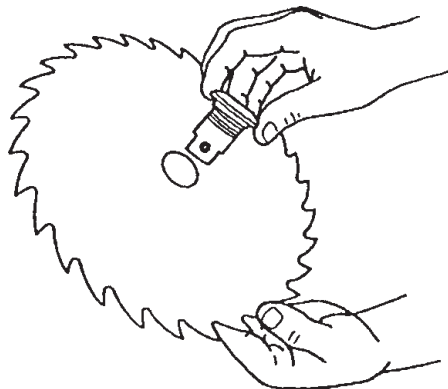

Figure B-59b

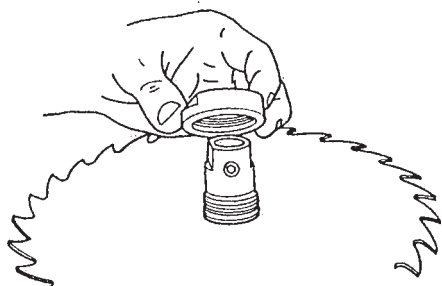

Figure B-59c

- c. Place the blade and arbor on your workbench with the nut pointing up.
- d. Hold the arbor with an adjustable wrench and tighten the arbor nut with the arbor wrench, as demonstrated in Figure B-59d. Another way to tighten the arbor nut is to clamp the arbor in a bench vise, as illustrated in Figure B-59e, and tighten the nut with the arbor wrench.

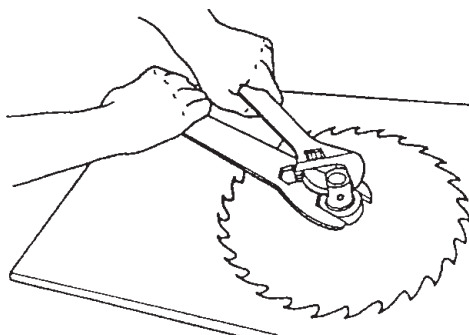

Figure B-59d

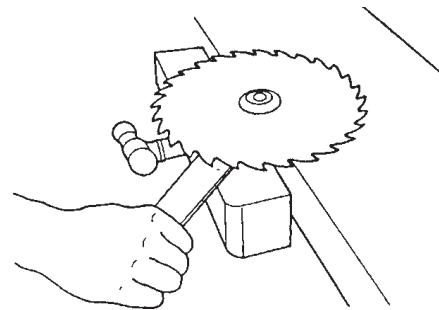

Figure B-59e

NOTE

The only time the saw blade is used without the upper or lower saw guards is during alignment and only after the Mark V is turned off and unplugged.

- 20. Mount the saw blade on the spindle and align the arbor set screw with the spindle knob's set screw, then use a 5/32" Allen wrench to tighten the arbor set screw, as seen in Figure B-60.
- 21. Reinstall the table insert (138) in the worktable.
- 22. Raise the worktable so that it clears the top of the saw blade.
- 23. Loosen the carriage lock and slide the carriage so the saw blade is directly beneath the slot in the table insert. See Figure B-61.

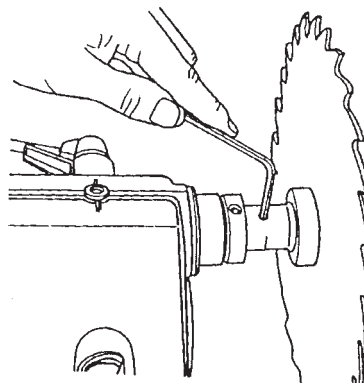

Figure B-60

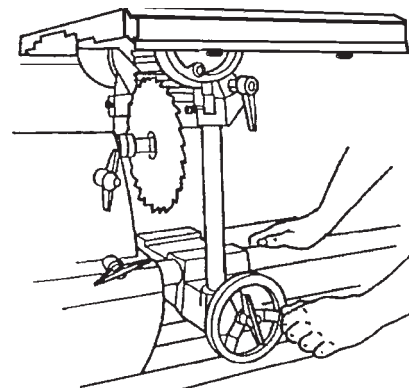

Figure B-61

24. Lower the worktable (but not all the way down) so the saw blade comes through the slot. Lock the table height, as seen in Figure B-62.

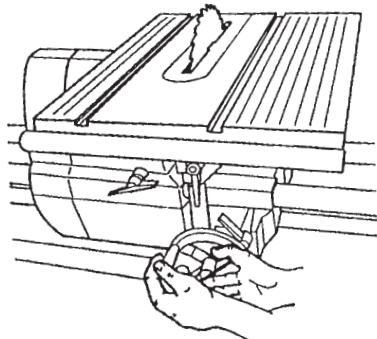

Figure B-62

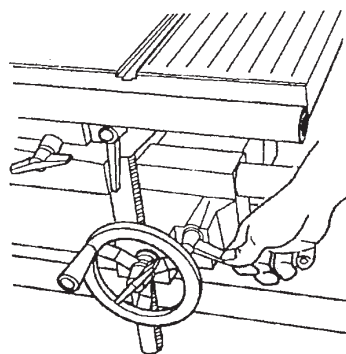

Figure B-63

26. Place the combination square against both the saw blade and worktable, as seen in Figure B-64. Make sure the square's blade does **not** touch a saw tooth and **does** rest in a gullet between teeth.

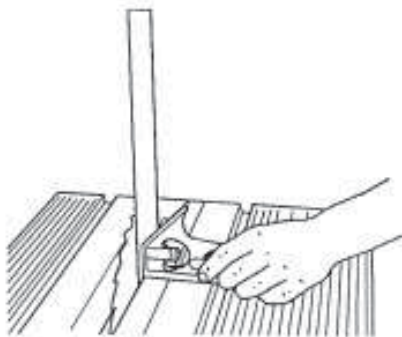

Figure B-64

27. If the worktable is not exactly perpendicular to the saw blade, adjust the worktable so it is perpendicular to the saw blade, then tighten the tilt lock.

28. To adjust the 0° stop, simultaneously depress the table stop pin and use a 1/2" wrench to adjust the stop bolt. The stop bolt should just contact the side of the stop pin. Once the stop

bolt is adjusted, the stop pin will "lock" back when the tilt lock is tightened. See Figure B-65.

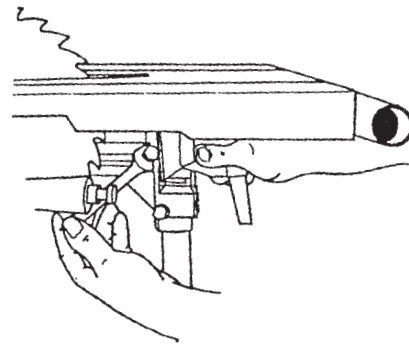

Figure B-65

29. Loosen the tilt lock, move the worktable, then depress the 0° stop pin until the stop bolt contacts it. Tighten the tilt lock, and recheck the setting by repeating Steps 26 through 28. See Figure B-66. (It is very important to recheck the setting!)

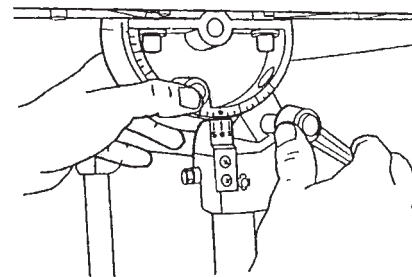

Figure B-66

ADJUST THE TABLE TILT INDICATOR

30. Tighten the table tilt lock and check that the "0" mark on the indicator aligns with the "0" mark on the trunnion ((149).

31. To adjust the scale, use a medium Phillips screwdriver to loosen the two screws which hold the indicator to the tie bar. See Figure B-67. Then while holding the indicator in position so the "0"s are aligned, retighten the screws.

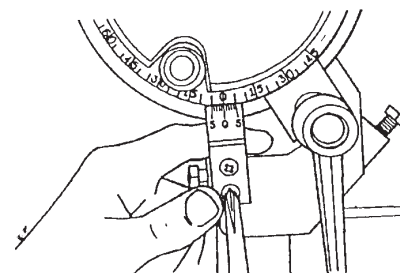

Figure B-67

ADJUST THE WORKTABLE'S 45° STOPS

32. Loosen the table height lock and raise the table until it clears the saw blade. Tighten the height lock.
33. Loosen the tilt lock and tilt the worktable to the right until it makes contact with the two 45° stop bolts (158).
34. Tighten the tilt lock only enough to allow movement with firm pressure.
35. Loosen the quill feed (shown in Figure B-68) and extend the quill so the saw blade is centered beneath the slot in the table insert. When it is centered, lock the quill feed.

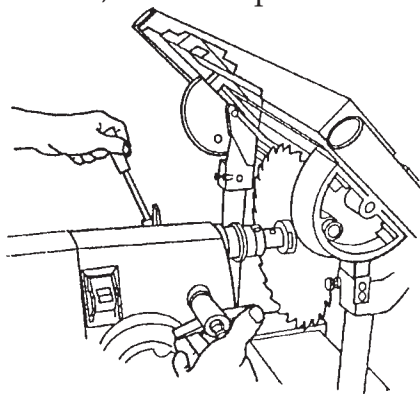

Figure B-68

36. Lower the worktable so the saw blade extends through the slot. See Figure B-69. Lock the table height.

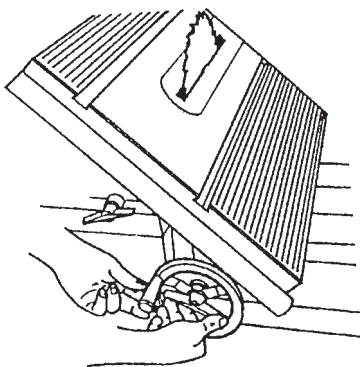

Figure B-69

37. Remove the blade from the combination square and place the square against the saw blade and the worktable, as shown in Figure B-70. Make sure the combination square doesn't rest on the table insert.

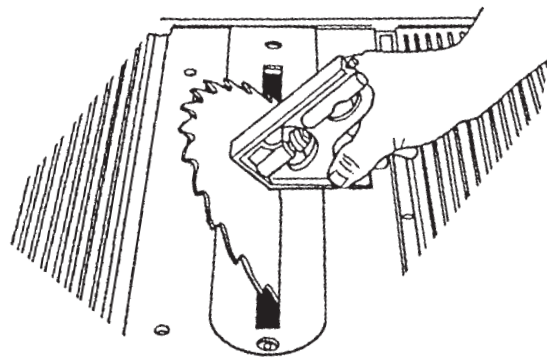

Figure B-70

38. If the worktable is not exactly 45° to the saw blade, adjust the worktable so it is.
39. Tighten the tilt lock, then use a 1/2" wrench to adjust the 45° stop on the front side of the worktable (shown in Figure B-71) and the back side of the worktable (shown in Figure B-72). The stops should just contact the underside of the table.
40. Loosen the tilt lock and move the table. To recheck the 45° stops, repeat Steps 35 through 39. (It is very important to recheck the setting!)

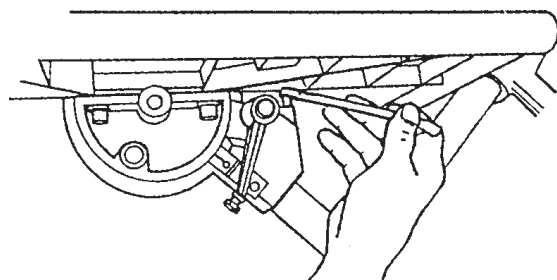

Figure B-71

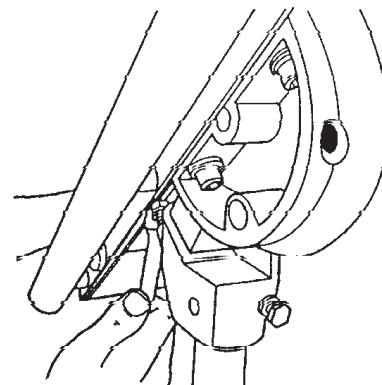

Figure B-72

ALIGN THE MITER GAUGE SLOTS

- 41. Return the worktable to the horizontal "0" stop and tighten the tilt lock. The carriage lock and headstock lock should also be tightened. Remove the table insert.
- 42. Place the miter gauge in the right miter gauge slot, and use a 5/32" Allen wrench to remove the quick clamp from the safety grip, as shown in Figure B-73.

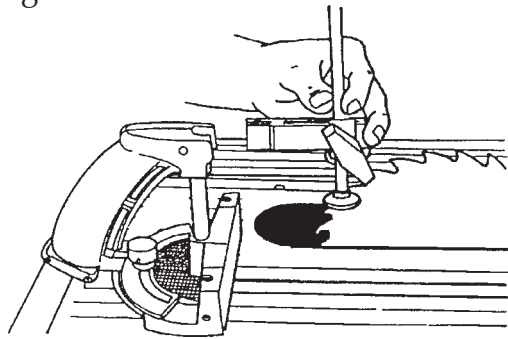

Figure B-73

- 43. Insert the long 5/32" Allen wrench through the miter gauge. Borrow a set screw from the lathe tool rest and use the short 5/32" Allen wrench to install it in either top miter gauge hole, as seen in Figure B-74. Place the tip of the long wrench against the front side of the saw blade and tighten the set screw.

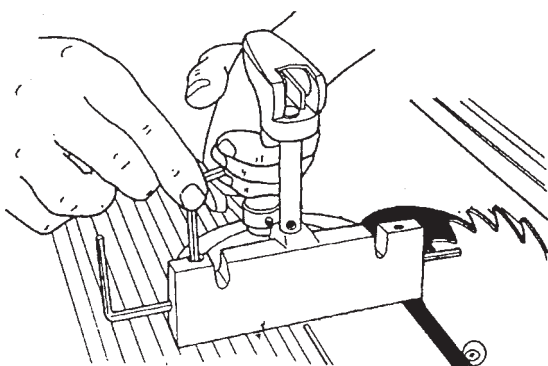

Figure B-74

- 44. Move the miter gauge from front to back along the saw blade, as shown in Figs. B-75 and B-76. If it hangs up on the blade or a gap develops, the miter gauge slots need to be aligned. Make sure the Allen wrench does not contact a saw blade tooth, because the tooth "set" will cause misalignment.

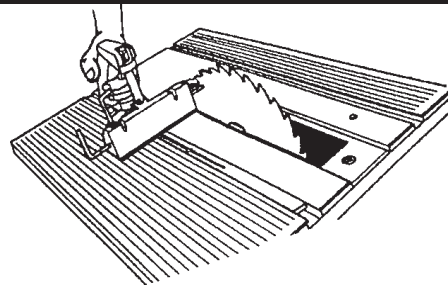

Figure B-75

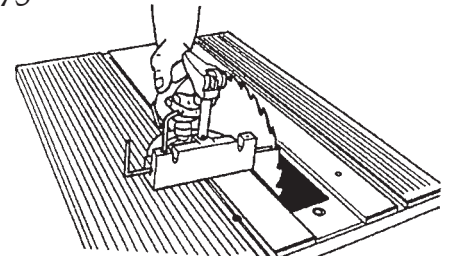

Figure B-76

- 45. If the miter slots need to be aligned, do the following:
 - a. Tilt the table to 45° and tighten the tilt lock.
 - b. Use a 5/16" Allen wrench to loosen all four bolts (147) which hold the worktable to the trunnions, as pointed out in Figure B-77. Loosen the bolts only enough to allow movement with firm pressure. See Figure B-78.

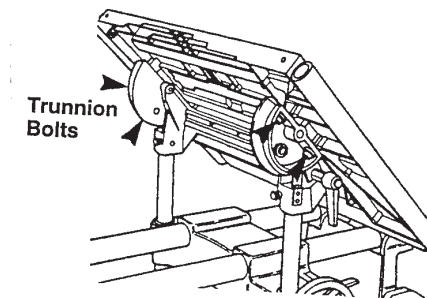
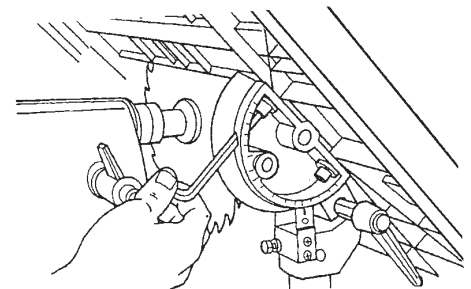

Figure B-77



NOTE Figure B-78

If you find it difficult to loosen the bolts, consider using a T-handle Allen wrench, or use a boxed wrench for extra torque. Another alternative is to use the hanging hole in an adjustable wrench, as demonstrated in Figure B-78a.

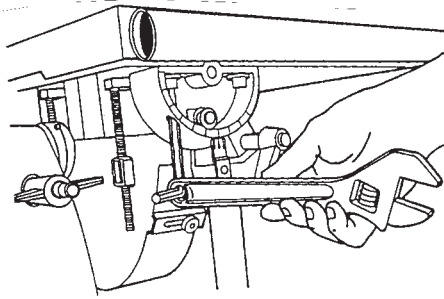

Figure B-78a

- c. Position the worktable back to the horizontal "0" and tighten the tilt lock.
- d. Adjust the worktable, then again move the miter gauge and wrench along the face of the saw blade until the wrench tip consistently contacts the entire blade surface.
- e. When the miter gauge slot is aligned, use the 5/16" Allen wrench to retighten the two trunnion bolts which are closer to the headstock. Then loosen the table tilt lock, tilt the worktable to 45°, and **retighten the table tilt lock**. Use the 5/16" Allen wrench to retighten the other two trunnion bolts.
- f. Loosen the table tilt lock and move the table, then return it to the horizontal "0" position. Recheck the slot alignment. If it is off, repeat Steps d and e.

NOTE

Tighten the bolts only after the table tilt lock is secured. Otherwise the worktable will bow or bind the next time the table tilt lock is tightened.

INSTALL THE TABLE INSERT IN THE WORKTABLE

- 46. Place the table insert in the worktable recess. Use a 5/32" Allen wrench to start both screws.

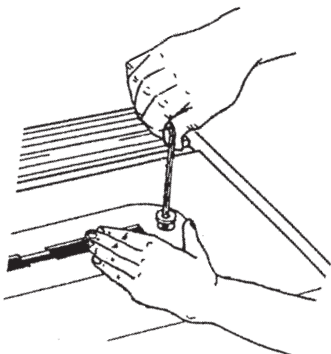

Figure B-79

- 47. First tighten the rear screw. Then the front of the insert will be sprung slightly above the table. Level the insert by placing your hand on the front of the insert, as in Figure B-79, and slowly turning the front screw until it draws the front of the insert flush with the worktable surface.

ADJUST THE MITER GAUGE GLIDES

- 48. Place the miter gauge in the worktable's miter gauge slot. See Figure B-80.

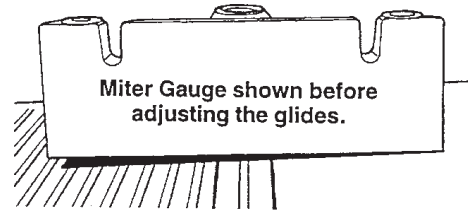

Figure B-80

- 49. Check to see if the miter gauge wobbles side-to-side. Also, slide it back and forth in the slot to check if the miter gauge scrapes against the table. If the miter gauge rocks or scrapes the table, adjust the glides.
- 50. If the glides need to be adjusted, do the following:
 - a. Remove the miter gauge from the slot and turn it over.
 - b. Use a medium screwdriver to screw the glides in or out, as illustrated in Figure B-81, so that the glides hold the miter gauge 1/64" to 1/32" off the worktable and the miter gauge does not rock in the slots.

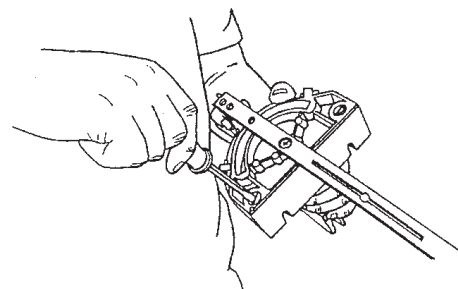

Figure B-81

- c. Return the miter gauge to the slot and recheck and re-adjust it, if needed.

ADJUST THE MITER GAUGE FACE

- 51. Remove the safety grip from the miter gauge. Make sure you keep the small, thin washer.
- 52. Put the miter gauge in the right slot and place the combination square against the saw blade and miter gauge face, as seen in Figure B-82.

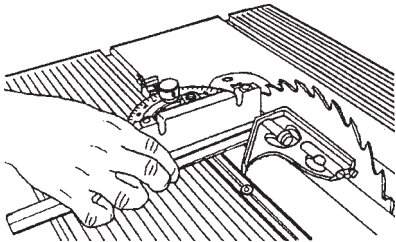

Figure B-82

- 53. If the miter gauge face is not perpendicular to the saw blade, do the following:
 - a. Use a long Allen wrench to loosen the lock knob (268) and adjust the miter gauge so it is perpendicular to the saw blade, then tighten the lock knob. See Figure B-83.
 - b. Use a medium screwdriver, loosen the screw (273) which holds the indicator plate (275), and set its "0" to the miter gauge's "90". Tighten the screw. See Figure B-84.

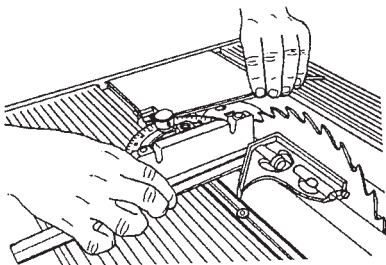

Figure B-83

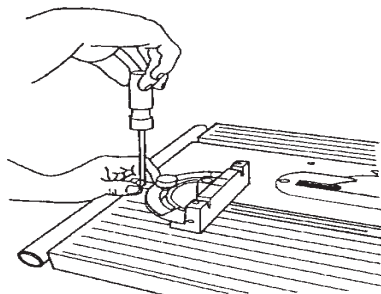

Figure B-84

ADJUST THE 90° POSITIVE STOP

- 54. Use a small screwdriver to back out the 90° stop screw 2 to 3 turns, as shown in Figure B-85.

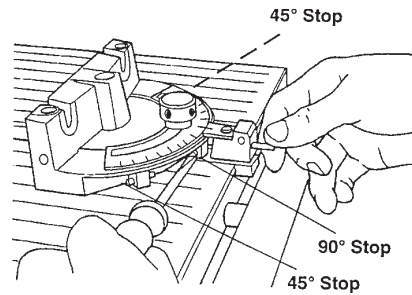

Figure B-85

- 55. Depress the plunger, then turn the stop screw until you feel it touch the plunger.
- 56. To re-check the stop setting, repeat Steps 52 through 55.

ADJUST BOTH 45° STOPS

- 57. Loosen the lock knob (268) and pull out the plunger. Then, at the same time, rotate the miter gauge and push in the plunger until it hits the 45° stop (there is one on each side of the 90° stop).
- 58. Use a combination square to set the miter gauge face at 45° to the saw blade. If the 45° stop needs adjustment, use a medium screwdriver to back out the 45° screw 2 to 3 turns.
- 59. Depress the plunger, then turn the stop screw until you feel it touch the plunger.
- 60. To recheck the stop setting, repeat Steps 54 through 59.
- 61. To adjust the other 45° stop, repeat Steps 57 through 60.

REMOVE THE SAW BLADE

- 62. Loosen the table height lock and raise the table so that it clears the saw blade, then tighten the lock. Unlock the carriage lock and move the worktable to the right.

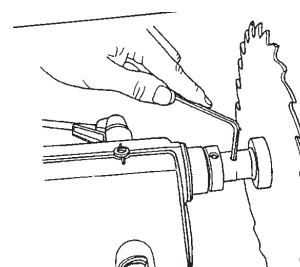

Figure B-86

- 63. Use the 5/32" Allen wrench to loosen the arbor set screw. Remove the saw blade. See Figure B-86.

- 64. Unlock the table height lock and lower the table to a comfortable working height. Tighten the lock.

ALIGN THE PRO FENCE PARALLEL WITH THE WORKTABLE

63. Place the miter gauge in the left slot of the worktable on the infeed side. Place the Pro Fence on the right side of the saw table.
64. Insert the long 5/32" Allen wrench through the miter gauge and secure it using the short 5/32" Allen wrench and a set screw borrowed from the tool rest.
65. Move the fence toward the Allen wrench until it just touches it.
66. Lock the lower fence lock handle first, then lock the upper fence lock handle to secure both ends of the pro fence.
67. Slide the miter gauge back and forth in the slot. The tip of the Allen wrench should keep in slight contact with the fence. Watch that you don't scratch the fence.
68. If the allen wrench pulls away from or binds against the fence, the fence needs aligning. If so, do the following:
 - a. Using the short 5/32" short Allen wrench, loosen the four button head cap screws (3), located on the top of the fence, slightly. They should be just tight enough to require firm pressure to align the fence.
 - b. Raise the upper fence lock handle only to unlock the rear of the fence.
 - c. Adjust the rear end of the fence so that it just touches the allen wrench as the miter gauge slides along the fence.
 - d. When alignment is reached, lock the upper fence lock handle. Slide the miter gauge back and forth to double check your alignment. Using the short 5/32" Allen wrench, tighten the four button head cap screws (3) completely.

ALIGN THE EXTENSION TABLE

NOTE

These instructions are for aligning the extension table on the right side of the headstock. You

can also follow these same procedures to align it to the left side of the headstock.

For most projects, align the extension table on the right side, since it can usually be used when placed on the left side. However, once the extension table is aligned on the right side, it cannot be transferred to the left side and still maintain precise alignment.

If you wish precise alignment on the left side, repeat the following instructions- but place the extension table on the left side in the headstock.

69. Mount the extension table in the Mark V's accessory base mount (on the right side) at a comfortable height, as shown in Figure B-99. Use a 1/2" wrench to loosen the bottom nuts holding the table base to the table approximately 1/4" from the table. This will allow you room for later adjustment.

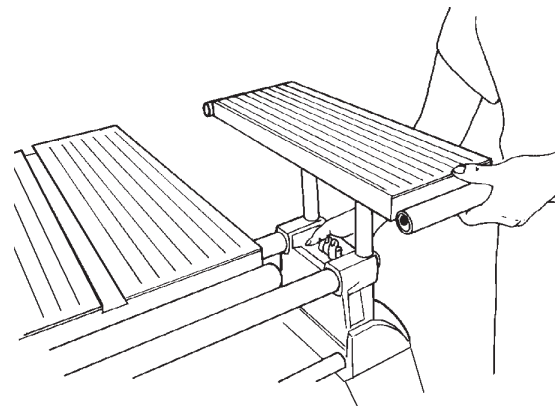

Figure B-99

70. The worktable should already be mounted in the carriage mount. Move the worktable next to the extension table and adjust it to about 1/4" above the extension table, as seen in Figure B-100.

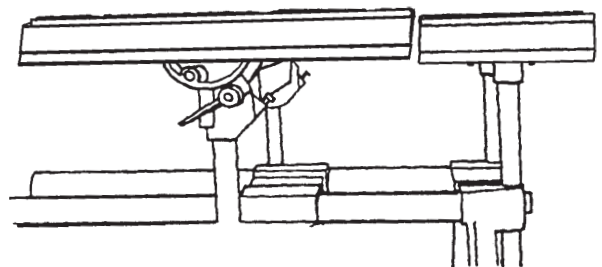

Figure B-100

- 71. Hold a straightedge against the **infeed edge** of both the worktable and extension table tubes, as in Figure B-101. Line up the extension table's infeed edge with the worktable's infeed edge. The elongated holes in the extension table's base permit you to slide the extension table forward and backward.
- 72. Hold a straightedge on the **infeed top surface** of both the worktable and the extension table, as shown in Figure B-102. As needed, adjust the top nuts located on the infeed side of the extension table, in order for the straightedge to be level across both the worktable and the extension table infeed sides. See Figure B-102a.

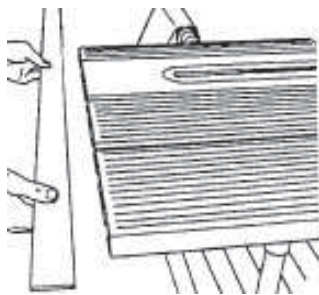

Figure B-101

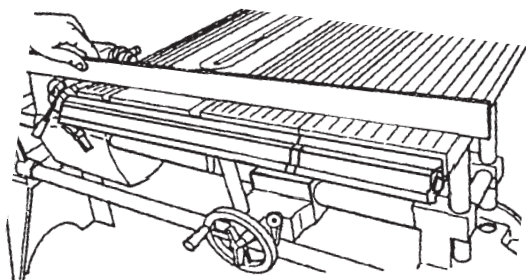

Figure B-102

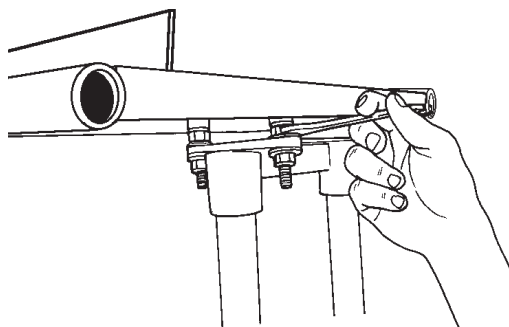

Figure B-102a

- 73. Hold the straightedge on the **outfeed top surface** of both the worktable and the extension table, as seen in Figure B-103. As needed, adjust the top nuts located on the outfeed side of the extension table, in order for the straightedge to be level across both the worktable and the extension table outfeed sides.
- 74. Double check the levelness at the infeed and outfeed sides of the table surfaces. All four top nuts (those nearest the table) used in leveling the extension table should be touching the base.

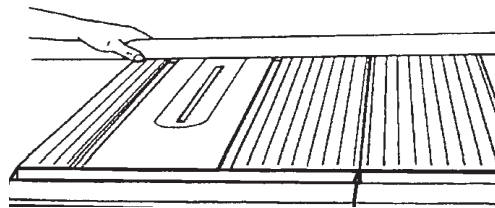

Figure B-103

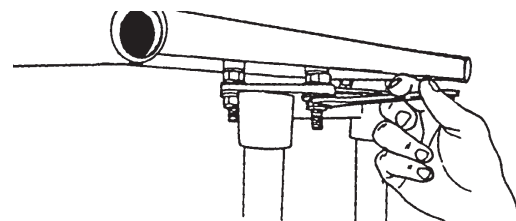

Figure 103a.

- 75. When the tables are aligned on three sides—**infeed side edge** (along the table tubes, as in Figure B-101), **infeed top surface** (as in Figure B-102), and **outfeed top surface** (as in Figure B-103) – securely tighten the bottom nut on each of the four studs, as seen in Figure 103a.



DO NOT overtighten the nuts. Tighten the nuts until they bottom out, then no more than 1/8 additional turn. Overtightening the nuts will stretch and damage the threads.

NOTE

If you move the Mark V to another location—especially one with an uneven floor—remember to re-check the extension table alignment.

ALIGN THE EXTENSION TABLE TUBES

- 76. Place the straightedge along the infeed-side tops of both the worktable and extension table tubes, as shown in Figure B-104.
- 77. If the extension table's tube is not aligned with the worktable's tube, use a 7/16" wrench to slightly loosen both keps nuts (248) attaching the tube to the extension table. Make the needed adjustments, then re-tighten the nuts. See Figure B-105.
- 78. Repeat Steps 85 and 86 for the extension table's tube located on the outfeed-side.

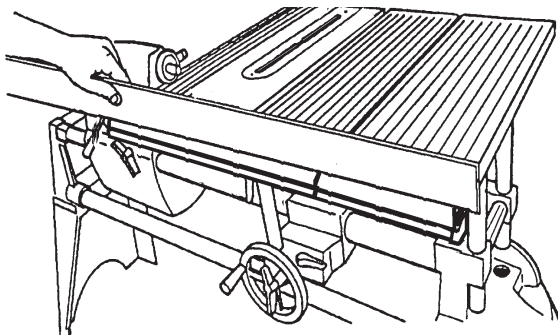

Figure B-104

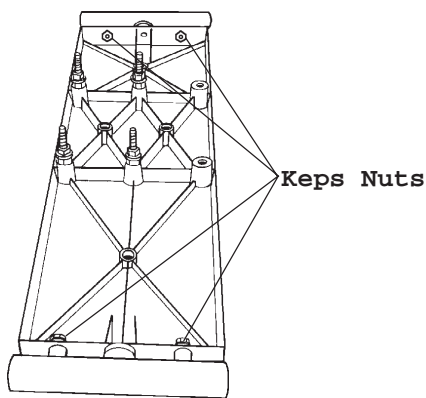

Figure B-105

MOUNT THE SAW GUARD

- 79. Loosen the accessory mount lock and remove the extension table. Loosen the table height lock and remove the worktable. Place the saw blade and arbor in the lower saw guard cover (204).

- 80. Fit the lower saw guard's clamp on the spindle quill (59). Line up the arbor set screw with the spindle knob's set screw (where the spindle flat is located). Use a 5/32" Allen wrench to tighten the arbor set screw, as shown in Figure B-106.

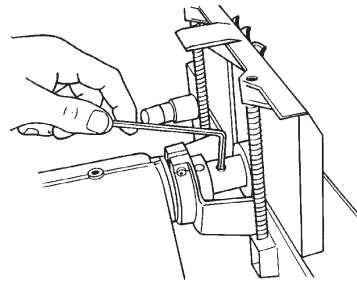

Figure B-106

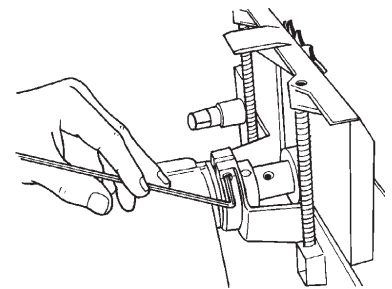

Figure B-107

- 87. Use the 5/32" Allen wrench to tighten the socket head screw (215) on the saw guard collar, as seen in Figure B-107.

INSTALL THE RIVING KNIFE

- 82. Loosen the guard lock knob (210) and insert the upper saw guard's riving knife (199) between the guard (213) and the lock plate (208), as demonstrated in Figure B-108.

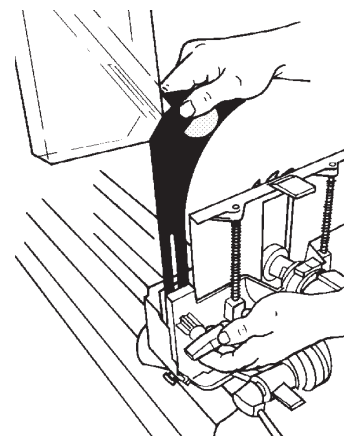

Figure B-108

83. Make sure the riving knife is fully seated between the guard and the lock plate, as in Figure B-109. The curved portion of the riving knife should be very close to the saw blade teeth (about 1/8"), as illustrated in Figure B-110. Tighten the guard lock knob (210). Look to see if the riving knife is centered with the saw blade, as shown in Figure B-111.

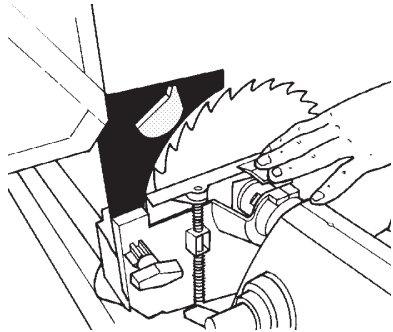

Figure B-109

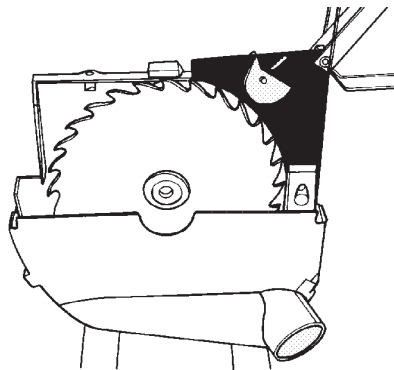

Figure B-110

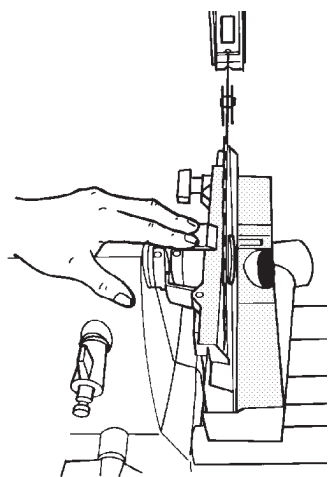

Figure B-111

84. If the riving knife is not centered with the saw blade, follow these steps:
- Notice which way the riving knife is not centered with the saw blade.
 - Unclamp and remove the upper saw guard, then remove the saw blade and lower saw guard.

- Use a 5/32" Allen wrench to adjust the stop screw (211) located below the lower saw guard's collar, see Figure B-112.
 - If the riving knife is to the **left** of the saw blade, back out the stop screw (counter-clockwise).
 - If the riving knife is to the **right** of the saw blade, screw in the stop screw (clockwise).
- Re-install the saw blade, lower saw guard and riving knife, according to Steps 88 through 92. If the riving knife is still not centered on the saw blade, repeat this Step 93.

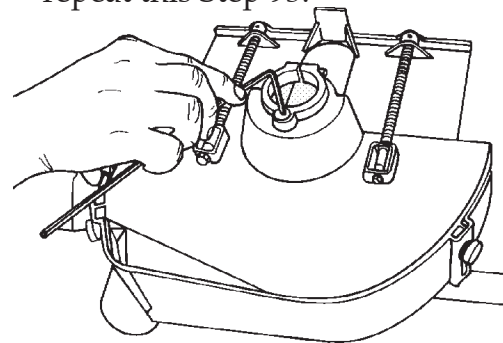

Figure B-112

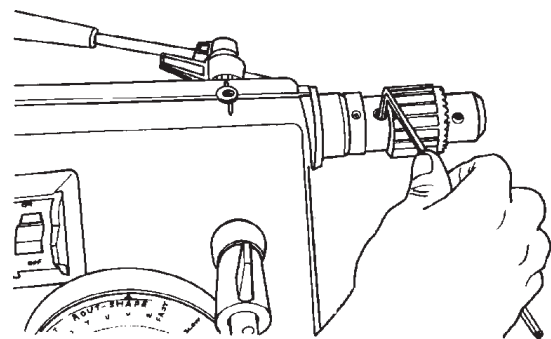

Figure B-113

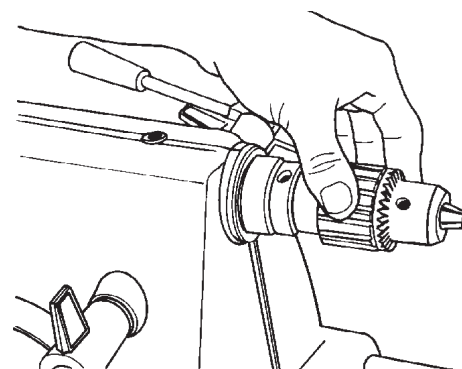

Figure B-114

ALIGN THE LATHE CENTERS

85. Remove the saw guards and the saw blade, then loosen the carriage and headstock locks. Move the headstock and carriage all the way to the right and lock them in place.
86. Mount the drill chuck on the spindle, as shown in Figure B-113. Completely close the chuck jaws, as in Figure B-114.
87. Mount the cup center into the tailstock's adjustable center, as seen in Figure B-115, then mount the tailstock into the base mount (right side). Tighten the mount lock.
88. Loosen the quill lock. Extend the quill (seen in Figure B-116), so the drill chuck almost touches the cup center point and the center point could fit into the chuck jaws.
89. If the center point does not "fit" into the chuck jaws, determine whether you need to adjust the cup center point horizontally and/or vertically. Then do the following:

- a. To adjust the cup center point **horizontally**, loosen the set screw that locks the adjustable center, as seen in Figure B-117. Rotate the adjustable center as needed to line up the cup center with the drill chuck, then tighten the set screw.
- b. To adjust the cup center point **vertically**, loosen the mount lock, then loosen the tailstock stop collars. Raise or lower the tailstock in the base mount until the cup center point vertically lines up with the drill chuck, then tighten the mount lock. Press the stop collars down firmly against the base mount and tighten the collar set screws, as shown in Figure B-118.

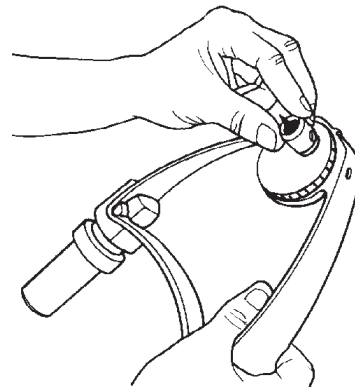

Figure B-115

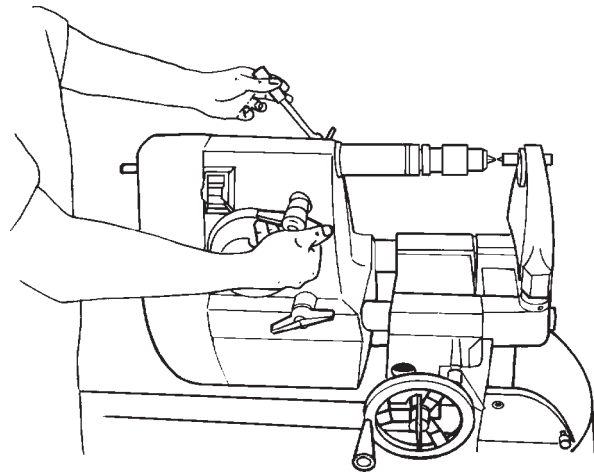

Figure B-116

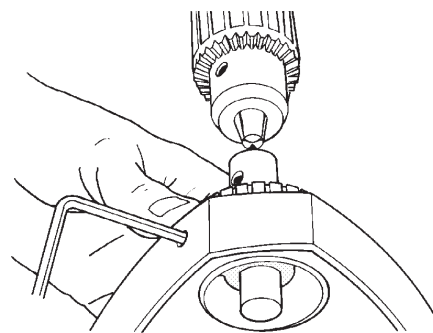

Figure B-117

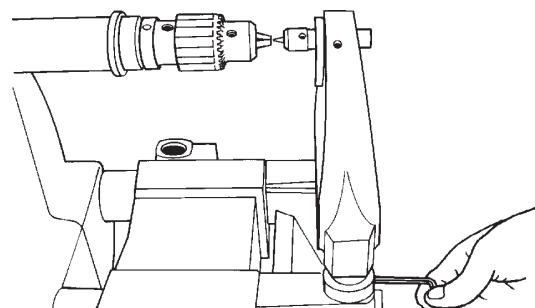

Figure B-118